

CONTENTS

OF YOUR OWNER'S MANUAL

CONTENTS

Introduction	1
• Welcome	1
• Features	1
• Included in Your Package	2
Setting Up and Adjusting Your Phone	3
• Desk or Tabletop Installation	3
• Wall Installation	4
• Direct Wall Mounting	5
• Installing the Handset Battery Pack	6
• Charging the Battery Pack	6
• Setting the Pulse/Tone Switch	7
• Adjusting Ringer Controls	8
• Automatic Digital Code Security	8
• Ringer On or Off	9
• Page/Find	9
• Attaching the Beltclip	9
• Cleaning Battery Contacts	9
Standard Use of Your New Phone	10
• Making & Receiving Calls	10
• Chain Dialing	11
• Changing Channels	11
• Flash & Call Waiting	11
 VoiceDial Programming Your Phone's Voice Memory	12
• Monitor Mode	12
• Voice Memory Entry Tips	13
• Storing a Phone Number in Voice Memory	14
• Storing a Mixed Mode Number	15
• Erasing a Stored Number	16
• Dialing a Stored Number	16
• Reviewing Numbers in Voice Memory	17
• Dial Announce On/Off	18
Troubleshooting	19
Specifications	21
Controls & Functions	inside back cover

NOTE: Foldout the back cover of this owner's manual to use the handy "Controls and Functions" page for reference.

INTRODUCTION

TO YOUR NEW VOICEDIAL PHONE

INTRODUCTION

WELCOME

Congratulations on your purchase of the Uniden EXV 98 cordless telephone integrated with VoiceDial technology. We designed this phone to exacting standards to provide you reliability, long life, and outstanding performance.

FEATURES

- VoiceDial Voice Recognition
- 30 Number Voice Memory
- 900 MHz Long Range Performance
- 40 Channel AutoScan
- UltraClear Plus Circuitry
- AutoTalk™
- Redial, Flash and Pause
- AutoSecure™
- Pulse/Tone Dialing
- AutoStandby™
- Page/Find
- 14 Day Long Life Battery
- 7 Hour Talk Time
- Speaker and Ringer Volume Control
- Any Key Answer
- Hearing Aid Compatible

VoiceDial is a technological breakthrough designed to recognize and respond to the sound of your voice. Just say the name of the person you want to call and VoiceDial automatically dials the number for you.

UltraClear Plus™ uses true compander circuitry to virtually eliminate background noise and to provide you with crystal clear reception.

To protect you against misbilled calls that might result from your phone being activated by other equipment, **Random Code™** digital security automatically selects one of over 65,000 digital security codes for the handset and base. In addition, the **AutoSecure™** feature electronically locks your phone when the handset is in the base.



To get the most from your phone, please read this owner's manual thoroughly. Also, be sure to complete and mail the product registration form.



If any of these items are missing or damaged, contact the Uniden Parts Department at (800)554-3988, 8:00 a.m. to 5:00 p.m. Central, Monday through Friday, or contact us on the web at www.uniden.com.

INCLUDED IN YOUR PACKAGE

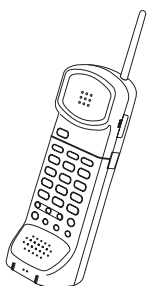

Handset

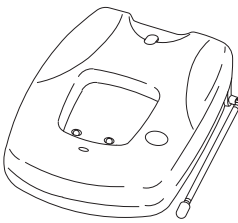

Base

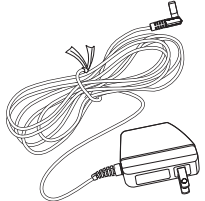

AC Adapter

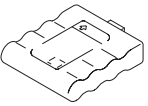

Rechargeable Battery

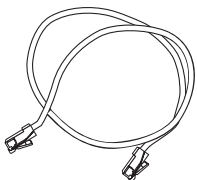

Short Telephone Cord

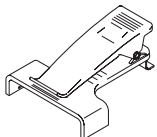

Beltclip

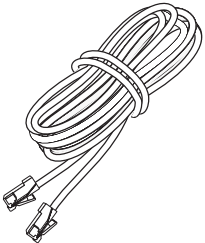

Long Telephone Cord

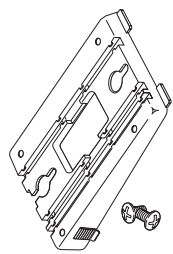

Wall Mount Adapter with Screws

- This Owner's Manual
- Precautions and Important Safety Instructions
- Registration Card

TIP

Before choosing a location for your phone, read the "Installation Considerations" included in the "Precautions and Important Safety Instructions" brochure.

DESK/TABLETOP INSTALLATION

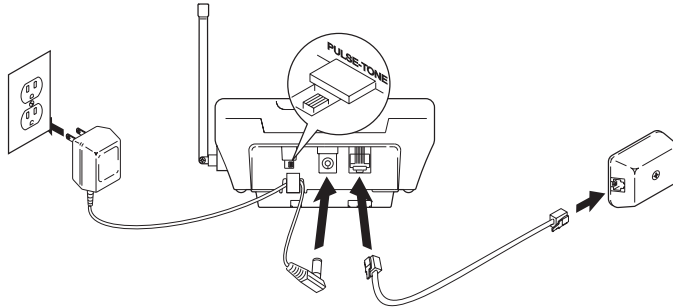

- 1) Plug the AC adapter cord into the 9 VDC input jack on the back of the base.
- 2) Wrap the AC adapter cord around the strain relief notch. *Place the power cord so that it does not create a trip hazard or where it could become chafed and create a fire or electrical hazard.*
- 3) Plug the AC adapter into a standard 120 VAC wall outlet.



Use only the Uniden AC adapter supplied with this phone. DO NOT use an outlet controlled by a wall switch.

- 4) Charge the battery (refer to "Charging the Battery Pack," page 6).
- 5) Plug one end of the long telephone cord into the **TEL LINE** jack on the back of the base.
- 6) Plug the other end of the cord into your telephone jack on the wall.
- 7) Place the base on a desk or tabletop. Then, place the handset into the base as shown. *In desk/tabletop installation, the handset is designed to stand vertically in the base. When using on a flat surface, **DO NOT** lay the handset down on the base.*
- 8) Raise the base antenna to the vertical position.

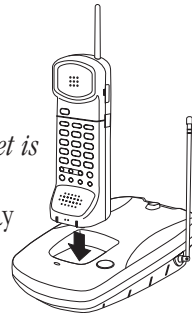

HINT

Before choosing a location for your phone, read the "Installation Considerations" included in the "Precautions and Important Safety Instructions" brochure.

CAUTION

Place the power cord so that it does not create a trip hazard or where it could become chafed and create a fire or electrical hazard.



NOTE: DO NOT use an outlet controlled by a wall switch.

WALL INSTALLATION

▼ Standard wall plate mounting

This phone can be mounted on a standard AT&T or GTE wall plate. To attach the wall mount adapter to the base:

- 1) Slide the wall mount adapter into the notches at the top of the base.
- 2) Pivot the wall mount adapter down and snap into place.
- 3) Plug the AC adapter into the base.
- 4) Wrap the AC adapter cord around the strain relief notch. Then, put the AC adapter cord inside the molded wiring channel. Plug the AC adapter into a standard 120 VAC wall outlet.

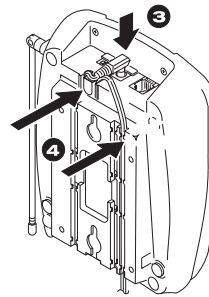
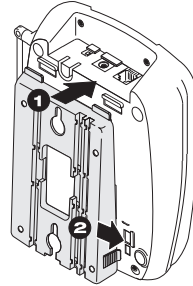

- 5) Plug one end of the short telephone cord into the **TEL LINE** jack on the base. Place the telephone cord inside the molded channel on the bottom of the base. *Before you plug the other end of the telephone cord into the modular jack on the wall, charge the battery (refer to "Charging the Battery Pack," page 6).*

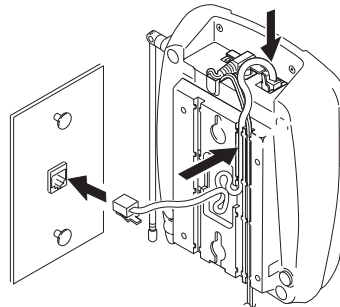

- 6) Place the base on the posts of the wall plate and push down until it's firmly seated.

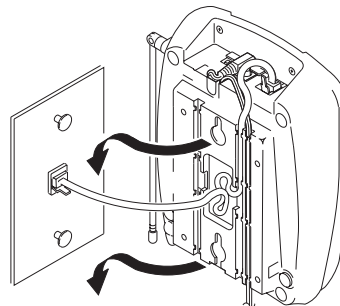



NOTE: Use **ONLY** the Uniden AC adapter supplied with this phone.



NOTE: **DO NOT** use an outlet controlled by a wall switch.



Before you plug the other end of the telephone cord into the modular jack on the wall, charge the battery. Refer to “Charging the Battery Pack,” page 6.

DIRECT WALL MOUNTING

If you do not have a standard wall plate, you can mount your phone directly on a wall. Before mounting your phone, consider the following:

- Select a location away from electrical cables, pipes, or other items behind the mounting location that could cause a hazard when inserting screws into the wall.
- Make sure the wall material can support the weight of the base and handset.
- Use the #10 screws included with the wall mount adapter kit.

- 1) Insert 2 mounting screws $3\text{-}15/16$ inches apart. Allow about $3/16$ of an inch between the wall and screw heads for mounting the phone.

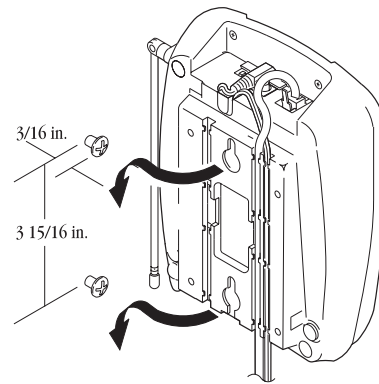

- 2) Follow “Standard Wall Plate Mounting” steps 1 through 4 on page 4.

- 3) Plug one end of the short telephone cord into the **TEL LINE** jack on the base. Put the cord inside the molded channel on the bottom of the base.
- 4) Place the base on the screws and push down until it's firmly seated.
- 5) Plug the AC adapter into a standard 120 VAC wall outlet. **DO NOT** use an outlet controlled by a wall switch.
- 6) Before you plug the other end of the telephone cord into the modular jack on the wall, charge the battery (refer to “Charging the Battery Pack,” page 6).

HINT

Before using your phone, fully charge the rechargeable Nickel-Cadmium battery pack. We recommend that the battery pack charges for 15-20 hours.



NOTE: In desk/tabletop use, the battery charges only in the vertical position. When wall mounted, hang the handset on the cradle. Use only the Uniden battery (BT-098) supplied with your phone.

HINT

When recharging the battery pack, allow 15 to 20 hours without interruption for the handset to fully recharge.

INSTALLING THE HANDSET BATTERY PACK

- 1) Press in on the battery cover release and slide the battery compartment cover down.

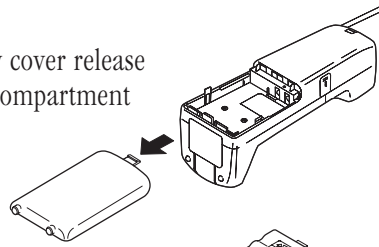

- 2) Put in the rechargeable Nickel-Cadmium battery pack. The battery pack fits with the electrical contacts touching. The label side on the battery pack should be facing up.

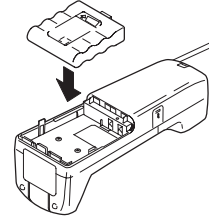

- 3) Slide on the battery cover and snap it into place.

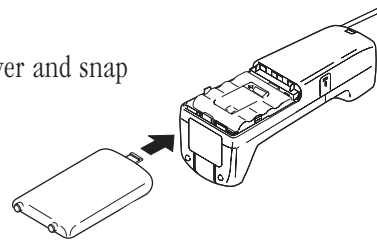

CHARGING THE BATTERY PACK

▼ Initial battery charging

Before using your phone for the first time, fully charge the rechargeable Nickel-Cadmium battery pack. We recommend that the battery pack charge for approximately 15-20 hours, without interruption, before plugging the phone line into your new phone.

- 1) Place the handset on the base.
- 2) Make sure the **status** LED lights. If the LED doesn't light, check to see that the AC adapter is plugged in and that the handset makes good contact with the base charging contacts.

Continued

CHARGING THE BATTERY PACK*continued***NOTE**

Allow 15 to 20 hours without interruption for the handset to fully recharge.

▼ *Battery memory effect*

Rechargeable batteries can develop a reduced charge capacity caused by repeated charge and discharge cycles. Rechargeable batteries that have developed this effect will not operate to their fullest capacity.

To avoid memory effect, before recharging, operate the unit until the rechargeable battery completely discharges. **DO NOT** “top off” the charge by placing the handset on the base after using for a short time.

To erase memory effect, operate the unit until the rechargeable battery is completely discharged, then fully recharge. Repeat this process at least 3 times.

▼ *Low battery indicator*

When the battery pack is very low and needs to be charged, the phone is programmed to eliminate its functions to save power. If the phone is not in use, the **talk** LED flashes every 3 seconds and none of the buttons will operate. If you are using the phone, the handset beeps and the **talk** LED flashes every 3 seconds. Complete your conversation as quickly as possible. Return the handset to the base to recharge the battery pack.

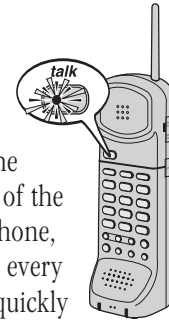
**SETTING THE PULSE/TONE SWITCH**

Be sure the **PULSE/TONE** switch is in the **TONE** position.

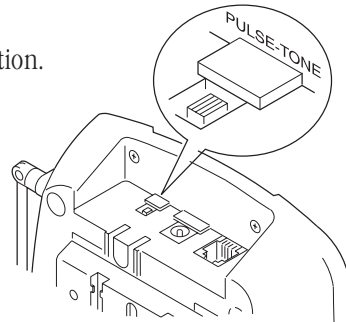
**TIP**

Most phone systems use tone dialing. Check with your local phone company if you are not sure whether your system is tone or pulse dialing.

IMPORTANT

You can change the receiver volume only when you are on a call.

TIP

If the base loses power while the handset is off the base, the digital code may be erased. If this happens, the handset won't function. You need to reestablish the connection between the handset and base.

ADJUSTING RINGER CONTROLS

▼ Ringer tone and volume

With no call in progress, press **ringer**. The phone has 3 ringer tones with 2 volume levels - one soft and one loud. Each time you press **ringer**, the ringer tone changes. Each time you press **volume**, the ringer volume changes.

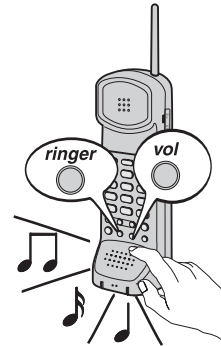

▼ Receiver volume

While on a call, press **volume**. The phone has two receiver volume levels - one soft and one loud. Each time you press **volume**, the receiver volume changes.



AUTOMATIC DIGITAL CODE SECURITY

To avoid unauthorized calls on your phone, a digital code was added to the EXV 98 phone. Only the handset and base share this digital code. The code will automatically set when you first use the phone.

▼ To change the digital code:

- 1) Place the handset on the base.
- 2) Press **page/find** on the base.
The handset will beep for about 6 seconds.
- 3) When the beeping stops, briefly remove the handset and then return it to the base.
*The **status LED** blinks to indicate that the digital security code is set to one of the more than 65,000 codes.*

▼ To establish communication between the handset and base:

- 1) Restore power to the base.
- 2) Place the handset on the base. *The **status LED** blinks to indicate that the digital security code is set.*

RINGER ON OR OFF

The ringer is on when the switch is in the **RING ON** position. To turn off the ringer, move the switch to the **BATT SAVE** position. Now, when a call comes in, the **talk** LED will flash but the ringer will be silent.

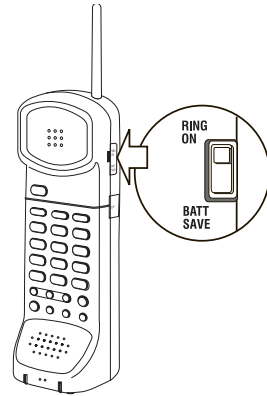
**PAGE/FIND**

To locate the handset (while it's off the base), press **page/find** on the base. The handset beeps for about 6 seconds.

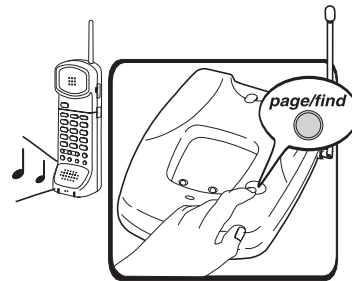
**ATTACHING THE BELTCLIP**

- 1) Put the tab (at the belt clip top) into the notch at the top of handset back.
- 2) Snap the bottom tabs into both **CLIP** notches until secure.

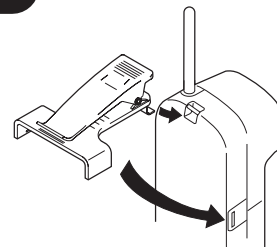
**CLEANING BATTERY CONTACTS**

To maintain a good charge, clean all charging contacts on the handset and base about once a month. Use a pencil eraser or other contact cleaner. **DO NOT** use any liquids or solvents.

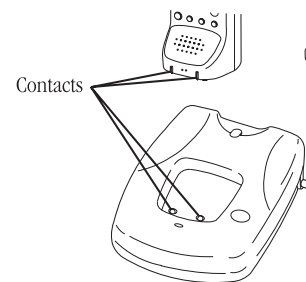

**WARNING**

When cleaning battery contacts, **DO NOT** use any liquids or solvents.

MAKING & RECEIVING CALLS

AutoTalk allows you to answer a call by just removing the handset from the base eliminating the need to push buttons or flip switches.

▼ Standard calls without using the memory features

Standard Calls without using the Memory Features	Handset On Base 	Handset Off Base 
To answer call	Pick up handset (AutoTalk).	Press any key.
To make a call	1) Pick up handset. 2) Press talk . 3) Listen for dial tone. 4) Dial the number.	1) Press talk . 2) Listen for dial tone. 3) Dial the number.
Hanging up	Press talk or return handset to base (AutoStandby).	
To redial	1) Pick up handset. 2) Press talk . 3) Listen for dial tone. 4) Press redial .	1) Press talk . 2) Listen for dial tone. 3) Press redial .



*Sometimes when you press **talk** to hang up the phone, you may get an error tone and the phone will not disconnect. If this happens, place the handset on the base or press **talk** again while holding the handset close to the base, or a wall switch.*

▼ Standard calls using the memory features

- 1) Press **voice/mem**.
- 2) You will hear:
 - Enter the 2-digit memory location number (01-30).
 - The number will automatically dial.

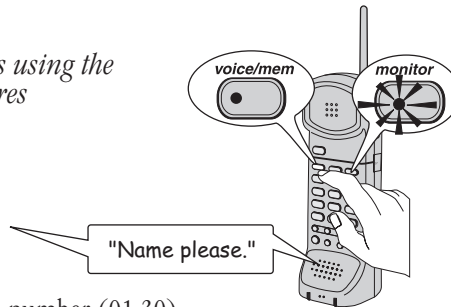

*NOTE: When you are ready to talk, press **monitor** to turn off the monitor mode*

CHAIN DIALING

On certain occasions, after dialing a number, you may be requested by the party or service you are calling to enter a special access code, such as an account number. You can enter this number into a memory location.

- 1) Store the access code into one of the memory numbers.
- 2) Dial the party or service main number.
- 3) When you need to enter the special number, press **voice/mem** followed by the access code's two-digit memory location number. You will hear the tones for the numbers.

CHANGING CHANNELS

To improve reception or eliminate background noise, press **channel**.

There may be a brief pause as your phone searches for the clearest channel available.

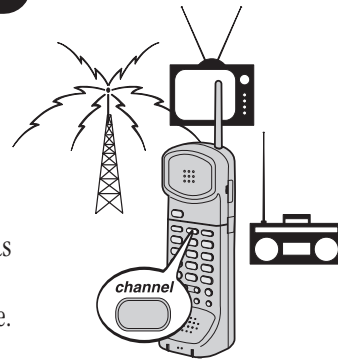

FLASH & CALL WAITING

If you have “call waiting” service and a call waiting tone sounds while you are on a call, press **flash** to accept the waiting call. There may be a short pause, then you will hear the new caller.

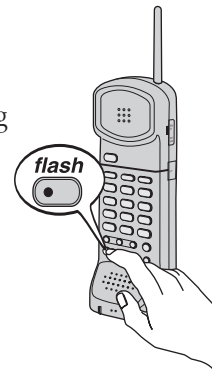

MONITOR MODE

The monitor mode feature lets you listen to the convenient voice prompts through the handset speaker rather than the earpiece.

Monitor mode is automatically

when you press the **voice/mem** key to dial a number, the **store** key

to program or the **rev** key to review. The **monitor** LED lights to indicate that the monitor mode is on. While in monitor mode, the earpiece is muted.

If you want to hear voice prompts through the earpiece, or

to talk to a caller, turn the monitor mode off by pressing **monitor**. The monitor LED will go off.

Monitor mode may be used to monitor a call without having the phone next to your ear. Since the handset microphone is turned off in monitor mode, you can consult another person in the room without the caller hearing you. Press **monitor** again to resume your conversation with the caller.

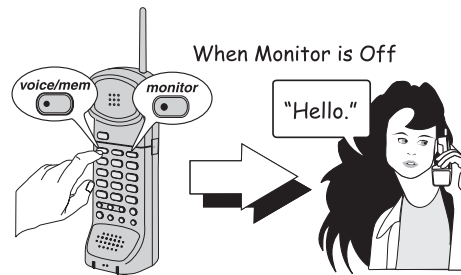
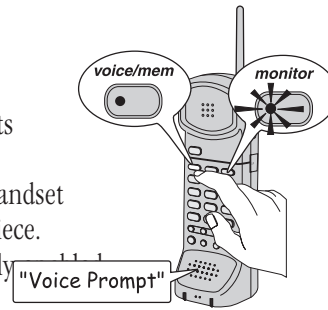

IMPORTANT

VoiceDial should not be used to access emergency numbers such as 911 (Police or Fire) or to summon other emergency services (ambulance, medical, security/alarm or the like). In an emergency, your voice may sound different due to stress (which is natural and of which you may not even be aware at the time) or injury or background noises may make your voice unidentifiable to VoiceDial.



VoiceDial is the world's first fully integrated speech synthesized I.C. (integrated circuit) in a cordless phone!

VOICE MEMORY ENTRY TIPS

VoiceDial is “speaker (voice) dependent” - it's designed to recognize the voice that programmed the name. If you program a memory location for “pizza delivery” and another person tries to VoiceDial “pizza delivery,” the phone may not recognize the new voice. But, when responding to the prompt “Answer yes or no,” the phone is speaker (voice) independent - it can recognize most voices.

- Excessive background noise will affect your voice entries. If you are in a noisy area, either go to a quiet area or turn off monitor mode.

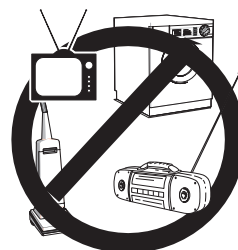

- Don't pause between first and last names.
- Speak in a consistent voice.
- Keep your voice entry name to less than 3 seconds.
- In the default monitor mode, hold the handset microphone about 8 to 12 inches from your mouth.
- When the voice prompt says “Say yes or no,” if you don't say anything within 6 seconds, you will hear “louder please.” If you still don't respond, the handset beeps and the programming procedure cancels.
- When the voice prompt says “Enter the phone number you want to store,” if you do not make an entry within 10 seconds, the handset beeps and the programming procedure cancels.
- To cancel a programming procedure, press **cancel**.
- Follow the voice prompts for additional guidance.
- You can't program the phone while you're on a call. If you get a call while you are programming

the phone, it will cancel the current memory operation.

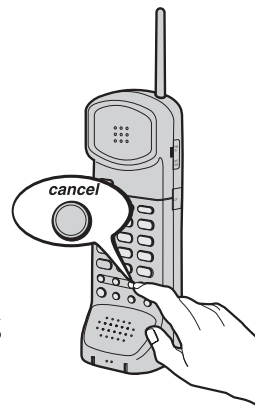

TIP

When the voice prompt says "Enter the phone number you want to store," if you do not make an entry within 10 seconds, the handset beeps and the programming procedure cancels.

TIP

When the voice prompt says "Say yes or no," if you don't say anything within 6 seconds, you will hear "louder please." If you still don't respond, the handset beeps and the programming procedure cancels.

TIP

If you need a pause to separate groups of numbers during dialing, press **pause**. This 4 second **pause** counts as one digit. Pressing **pause** more than once increases the length of the pause between numbers.

STORING A PHONE NUMBER IN MEMORY

With VoiceDial, programming is easy. Just follow the preprogrammed voice prompts.

- 1) Remove the handset from the base.

- 2) Press **store**.

The **talk** LED blinks and the monitor LED lights.

You will hear:

"Store mode. Enter the 2-digit memory location."

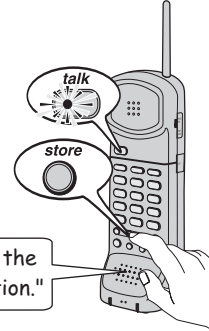

For example: Press 0, then 1.



NOTE: To automatically select the first available (empty) memory location, press 0, then 0.

- 3) You will hear:

"Say the name you want to store."

Example: say "John Smith."

Then you will hear:

"Please repeat."

To confirm, repeat the name, "John Smith."

If you don't respond within 6 seconds, you will hear "louder please." If you still don't respond, the handset beeps and the programming procedure cancels.



NOTE: You can skip the VoiceDial and enter a phone number in memory without a name. Enter the number on the keypad, then press **store** (go to step 5).

- 4) You will hear:

"On the keypad, enter the phone number then press **store**."

Use the keypad to enter the number you want to store (up to 16 digits).

For example: enter 555-5555; then press **store**.

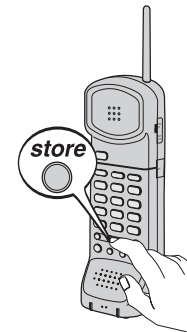

- 5) You will hear:

"555 5555 stored memory 01."

Then, you will hear a confirmation beep.

TIP

When the voice prompt says "Enter the phone number you want to store," if you do not make an entry within 10 seconds, the handset beeps and the programming procedure cancels.

TIP

When the voice prompt says "Say yes or no," if you don't say anything within 6 seconds, you will hear "louder please." If you still don't respond, the handset beeps and the programming procedure cancels.

TIP

If you need a pause to separate groups of numbers during dialing, press **pause**. This 4 second **pause** counts as one digit. Pressing **pause** more than once increases the length of the pause between numbers.

STORING A MIXED MODE NUMBER

If your phone service is set up for pulse dialing, you can store a mixed mode number to easily access automated services (such as banking) that require tones within their systems.

- 1) Remove the handset from the base.
- 2) Press **store**. The **talk** LED blinks.

You will hear: "Store mode. Enter the 2-digit memory location."

For example: Press 0, then 1.

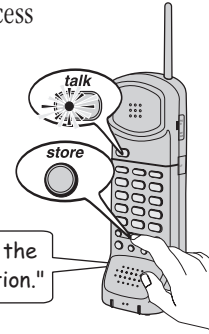

NOTE: To automatically select the first available (empty) memory location, press 0, then 0.

- 3) You will hear: "Say the name you want to store."

For example: say "My Bank."

Then, you will hear: "Please repeat."

To confirm, repeat the name "My Bank."



NOTE: To enter a number into memory without a name, skip voice entry and go to step 4.

- 4) You will hear: "On the keypad, enter the phone number then press **store**."

Enter the number you want to store in pulse mode on the keypad.

- 5) Press ***** (tone) on the handset.

- 6) Enter the number to be dialed in tone mode (such as an account number).
For example: 1 2 3 4.

- 7) Then press **store**.

8) You will hear: "555 5555 star 1234 stored memory 01."

Then, you will hear a confirmation beep.

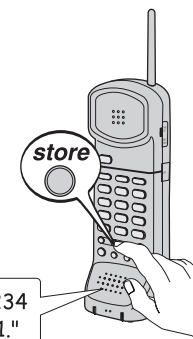

TIP

When the voice prompt says "Replace memory [location number]. Say yes or no," if you don't say anything within 6 seconds, you will hear "louder please." If you still don't respond, the handset beeps and the programming procedure cancels.

HINT

When you are ready to talk on the phone, press **monitor** to turn off monitor mode.

ERASING A STORED NUMBER

1) Remove the handset from the base.

2) Press **store**.

You will hear:

"Store mode. Enter the 2-digit memory location."

3) Enter the 2-digit memory location number that you want to erase. Our example is 01.

You will hear:

"Replace memory zero one? Say yes or no."

4) Say "Yes." This erases the memory location.

5) Press **store**.

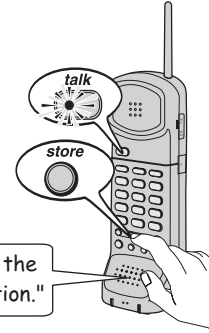

DIALING A STORED NUMBER

1) Remove the handset from the base.

2) Press **voice/mem**.

3) You will hear:

"Name please."

Say the location name or enter the 2-digit location number (01-30).

4) The number will automatically dial.

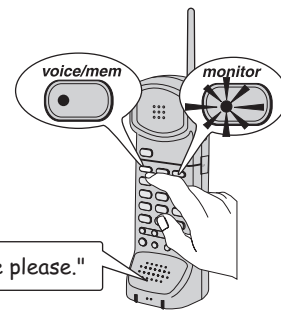

REVIEWING NUMBERS IN MEMORY

1) Press **rev**. The **talk** LED flashes.

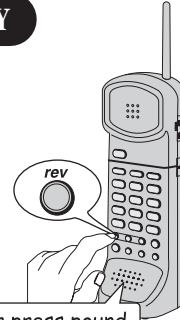

2) You will hear:

"Review mode. Say name or press pound (#) for next, star (*) for previous."

For example: You've programmed John Smith's phone number, 555-5555, into memory location 01.

Press (*). You will hear:

"Memory 01, 555-5555."

3) To dial the announced number, simply press **talk** before you hear the last digit.

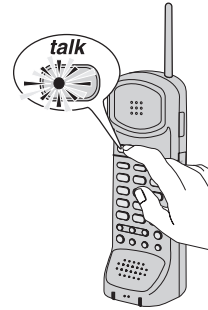

4) To hear the number in the next memory location, press (#).

Or, to hear the number in the previous location, press (*).

5) If you don't press (*) or (#), you will hear all your programmed memory locations one at a time from the lowest to the highest memory location number.

If you want to dial an announced number, press **talk** before you hear the last digit.

HINT

When you are ready to talk on the phone, press **monitor** to turn off monitor mode.



TIP

For faster dialing,
you can turn off the
“Dialing [number]”
announcement.

DIAL ANNOUNCE ON/OFF

- ▼ *To turn the “dialing” announcement off*
 - Press **store** and then **#**. You will hear a confirmation beep. The dialing announcement is off.

- ▼ *To turn the “dialing” announcement on*
 - Press **store** and then *****. You will hear a confirmation beep. The dialing announcement is on.

TROUBLESHOOTING

If your cordless telephone is not performing to your expectations, please try these simple steps first.

PROBLEM	SUGGESTION
You can hear the caller, but they can't hear you.	<ul style="list-style-type: none"> • Make certain the monitor mode is off. The monitor LED should be off.
While trying to VoiceDial, you keep getting the prompt, <i>"Name not recognized, please repeat."</i>	<ul style="list-style-type: none"> • Hold the handset about 8 to 12 inches away and directly in front of your mouth. • Speak clearly and consistently. • Background noise affects your entry. Move to a quiet area or turn off the monitor mode. • Say the first and last name without a pause.
While trying to VoiceDial, you say the name "John Smith," but the phone dials "Al Jones."	<ul style="list-style-type: none"> • Reprogram the entry. • Reprogram the entry with a different location name.
While trying to VoiceDial, your phone often dials wrong entries.	<ul style="list-style-type: none"> • Speak naturally and consistently. Your voice may be different due to illness or stress. • If the phone is used by several people, use different names for the locations.
When you are programming names into memory, you keep getting the prompt, <i>"Please try again. Say the name you want to store."</i>	<ul style="list-style-type: none"> • Hold the handset about 8 to 12 inches away and directly in front of your mouth. • Speak clearly and consistently for both the first and confirmation entries. • Say the first and last name without a pause. • Remember, background noise affects your entry. Move to a quiet area or turn off the monitor mode.
The charge light won't come on when the handset is placed in the base.	<ul style="list-style-type: none"> • Make sure the AC adapter is plugged into the base and wall outlet. • Make sure the handset is properly seated in base unit. • Make sure the charging contacts on the handset and base are clean. • If the phone is desk or tabletop installed, make sure the handset is in the vertical position on the base.
The audio sounds weak and/or scratchy.	<ul style="list-style-type: none"> • Make sure that the base antenna is in a vertical position. • Move the handset and/or base to different locations and try again. • Press channel to select another channel.
Can't make or receive calls.	<ul style="list-style-type: none"> • Check both ends of the base telephone line cord. • Make sure the AC adapter is plugged into the base and wall outlet. • Disconnect the AC adapter for a few minutes, and then reconnect it.

PROBLEM	SUGGESTION
Handset doesn't ring or receive a page.	<ul style="list-style-type: none"> • The Nickel-Cadmium battery pack may be weak. Charge the battery on the base for 15 to 20 hours without interruption. • Raise the base antenna vertically. • The handset may be too far away from the base. • Place the base away from noise sources. • The digital security code may be erased. Reset the digital code. • Make certain that the ringer on/off switch is in the RING ON position.
You hear only continuous static from handset.	<ul style="list-style-type: none"> • The power has been interrupted during a call. • Restore power to the base. Make sure the phone is not plugged into an outlet controlled by a wall switch.
Handset does not fully charge.	<ul style="list-style-type: none"> • If the phone is desk or tabletop installed, make sure the handset is in the vertical position and the contacts are touching.

If you are still unable to resolve the problems, contact Uniden Customer Service at (800) 297-1023, 8:00 a.m. to 5:00 p.m. Central, Monday through Friday.

SPECIFICATIONS

OF YOUR PHONE

SPECIFICATIONS

GENERAL

The EXV 98 complies with FCC Parts 15 and 68.

Frequency control: PLL

Modulation: FM

Operating temperature: -10° to 50° C

BASE

Receive frequency: 902.078 to 904.030 MHz (40 channels)

Transmit frequency: 925.999 to 927.950 MHz (40 channels)

Power requirements: 9 V 210 mA (from AC adapter)

Size: 5-1/2 in.(W) x 2-1/4 in. (D) x 7-5/8 in. (H)

Weight: Approx. 11.1 oz.

HANDSET

Receive frequency: 925.999 to 927.950 MHz (40 channels)

Transmit frequency: 902.078 to 904.030 MHz (40 channels)

Power requirements: Rechargeable Ni-Cd battery pack

Size (without antenna): 2-1/4 in. (W) x 2 in. (D) x 7-1/4 in. (H)

Weight: Approx. 10 oz. (including battery)

Battery: BT-098

Capacity 600 mAh, 4.8V

Talk mode 7 hours

Standby mode 14 days

Specifications, features, and availability of optional accessories are all subject to change without prior notice.

CONTROLS & FUNCTIONS

